



# SPM-3000

*Micro Guardian Space Pressure Monitor and Alarm System*

*Operation & Maintenance Manual*

---

*Engineered for accuracy, applicability, durability and simplicity*

# TABLE OF CONTENTS

TABLE OF CONTENTS.....	i
1. INTRODUCTION .....	1
1.1. BASIC OPERATION .....	1
1.2. SPECIFICATIONS.....	1
1.2.1. Power Supply .....	1
1.2.2. Power Consumption.....	1
1.2.3. Digital Input.....	1
1.2.4. Process Output Options.....	1
1.2.5. Alarm Relay Output.....	1
1.3. SAFETY .....	2
1.3.1. Electrical Connections .....	2
1.3.2. Static Electricity.....	2
2. INSTALLATION .....	3
2.1. Dimensions .....	3
2.2. Mechanical Installation.....	3
2.3. ELECTRICAL & PNEUMATIC INSTALLATION.....	4
2.3.1. Front Component Layout.....	4
2.3.2. Back Component and Connector Layout.....	5
3. PRODUCT FEATURES AND DESCRIPTIONS.....	6
3.1.1. Off Mode Selects .....	6
3.1.2. RPM Output.....	6
3.1.3. Lonworks / Bacnet / Modbus Output.....	6
3.1.4. IrDA Port .....	7
3.1.5. LCD.....	7
3.1.6. Audible Alarm .....	7
3.1.7. LED's.....	7
3.1.8. Buttons & Switches.....	8
4. FIELD MENUS .....	9
4.1. ACCESSING FIELD MENUS.....	9
4.2. FIELD MENUS .....	9
4.3. LOW ALARM.....	9
4.4. HIGH ALARM.....	9
4.5. ALARM DELAY.....	10
4.6. AUDIBLE ALARM.....	10
4.7. DISPLAY FILTER.....	10
4.8. OPERATING MODE .....	10
4.9. MAC CODE (BACNET, MODBUS & RPM COMMUNICATION) .....	10
4.10. INSTANCE.....	10
4.11. BAUD RATE.....	11
5. FIELD CALIBRATION .....	12
5.1. ZERO CALIBRATION .....	12
5.1.1. Procedure .....	12
5.2. BIDIRECTIONAL SPAN CALIBRATION .....	12
5.2.1. Equipment Required .....	12
5.2.2. Procedure .....	12
5.3. UNIDIRECTIONAL SPAN CALIBRATION .....	13
5.3.1. Equipment Required .....	13
5.3.2. Procedure .....	13
6. TROUBLESHOOTING GUIDE .....	15

# 1. INTRODUCTION

This user manual provides information on product features and guides you through all basic functions.

## 1.1. BASIC OPERATION

The Micro Guardian is a true differential space pressure measurement system. The Micro Guardian integrates the newest microprocessor technologies with state-of-the-art, industrial grade, highly accurate, ultra low range differential pressure sensing cells. The combination of these two technologies ensures exceptional accuracy and long-term stability.

The Micro Guardian is a complete system package including space and reference pressure sensors and a central signal processing module. The central module includes an in-wall mounting box, local LED indication of alarm status and operational mode, audible alarm with alarm acknowledge button, and an optional LCD for local display of the space pressure. Device monitoring and configuration is performed via LonWorks®, BACnet®-MS/TP or Modbus communication networks. Additionally, the monitor can be configured locally via Field Menu or IR communication using a laptop or Palm Tungsten E2® (or equivalent). A separate communication port is dedicated for connection to an optional Paragon Remote Pressure Monitor. Communication network variables include the measured space pressure, high and low pressure alarm values, operational mode selection, alarm status, alarm delay value and audible alarm on/off selection.

The Micro Guardian also incorporates a form C SPDT (Single Pole Double Throw) room pressure alarm relay for remote alarm activation and an analog output signal linear to the measured space differential pressure.

## 1.2. SPECIFICATIONS

### 1.2.1. Power Supply

20 to 28 VAC/DC

### 1.2.2. Power Consumption

125mA at 24VAC

### 1.2.3. Digital Input

Remote Alarm Disable (Dry Contact)

### 1.2.4. Process Output Options

0-10VDC

4-20mA (700Ω max. load)

### 1.2.5. Alarm Relay Output

1 Amp at 30VDC

3 Amps at 125VAC

2 Amps at 250VAC resistive load

## **1.3. SAFETY**

### **1.3.1. Electrical Connections**

Before any electrical connections are made, ensure the **POWER SWITCH** is in the **OFF** position.

### **1.3.2. Static Electricity**

The circuit board contains components which are susceptible to damage caused by static electrical discharge. Should it be necessary to remove the circuit board from the enclosure, appropriate precautions must first be taken to ensure that the operator and the circuit board are at the same electrical potential.

## 2. INSTALLATION

### 2.1. DIMENSIONS

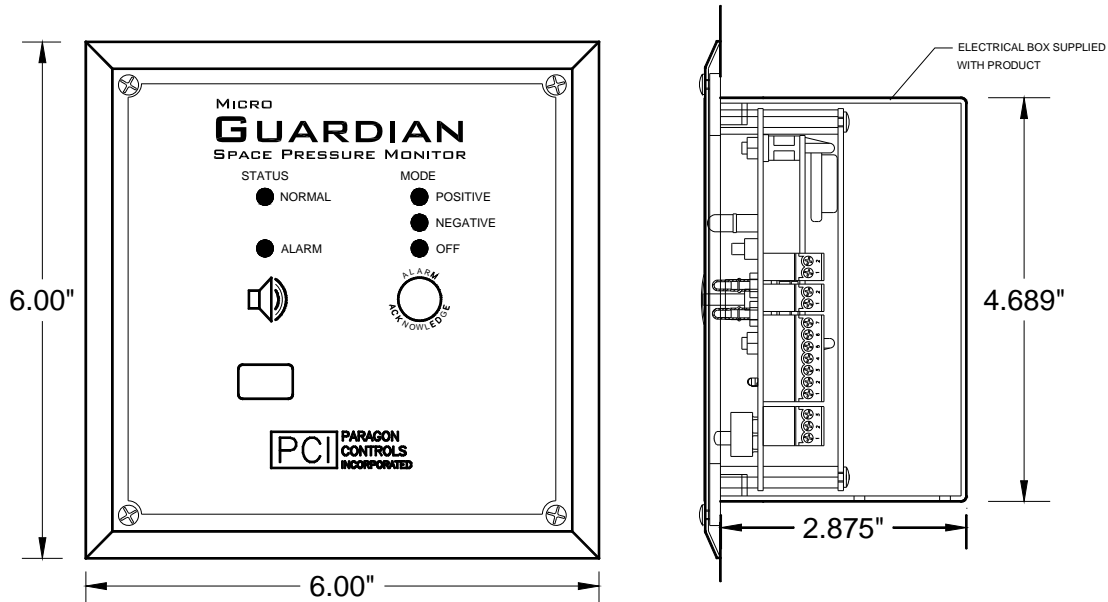

### 2.2. MECHANICAL INSTALLATION

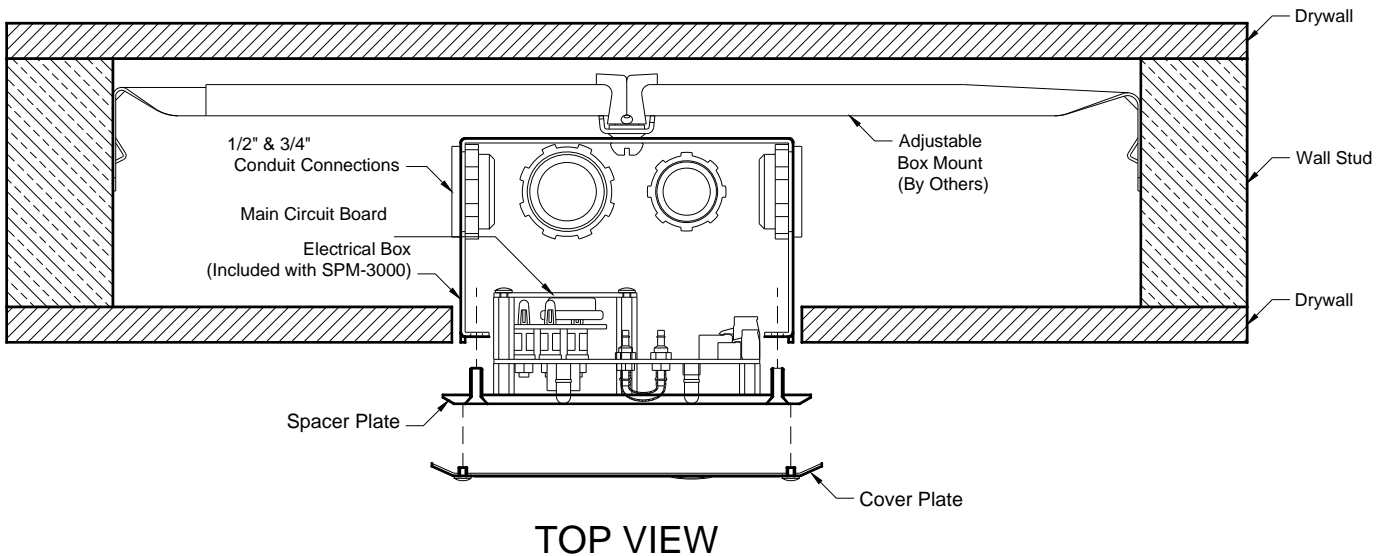

## 2.3. ELECTRICAL & PNEUMATIC INSTALLATION

### 2.3.1. Front Component Layout

Refer to Figure below for clarification on the front component layout.

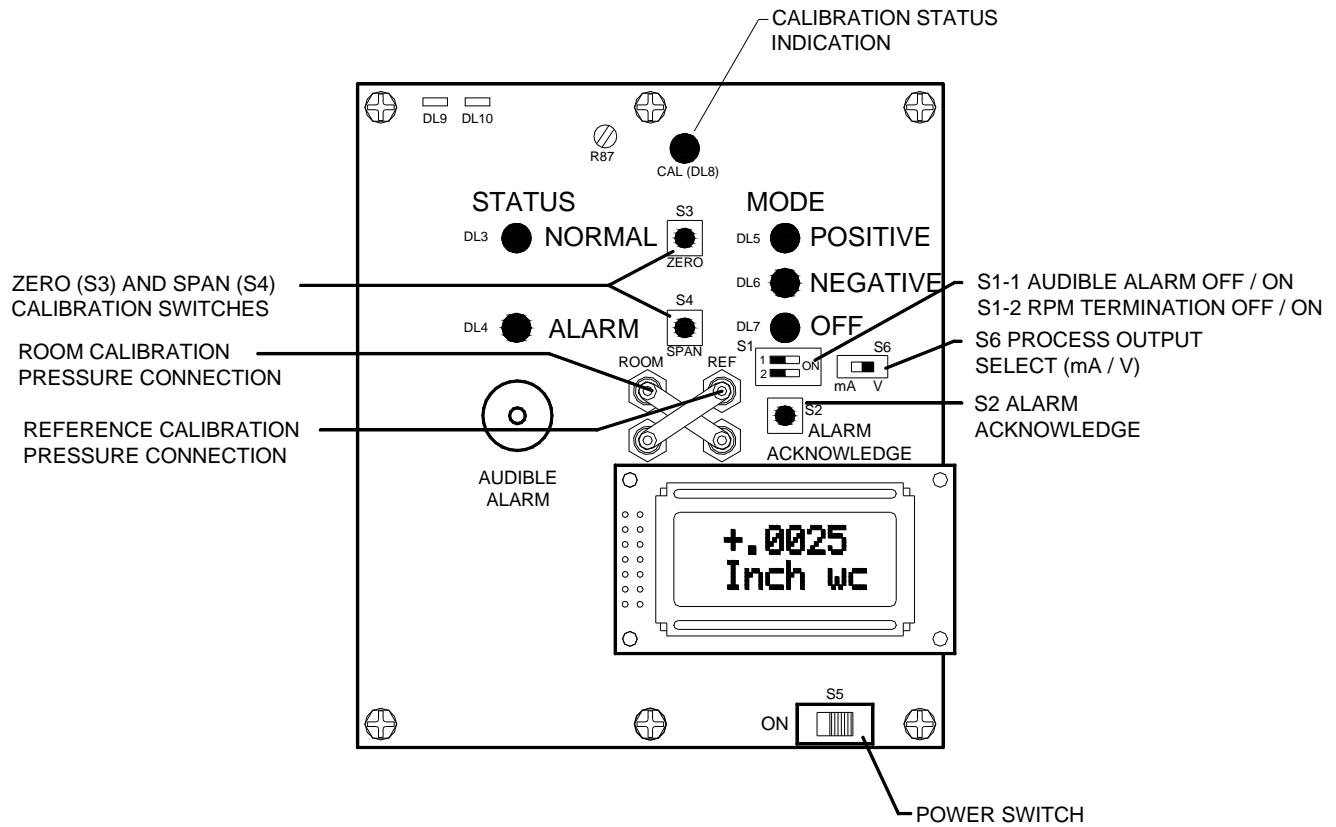

### 2.3.2. Back Component and Connector Layout

Refer to Figure below for clarification on the back component and connector layout.

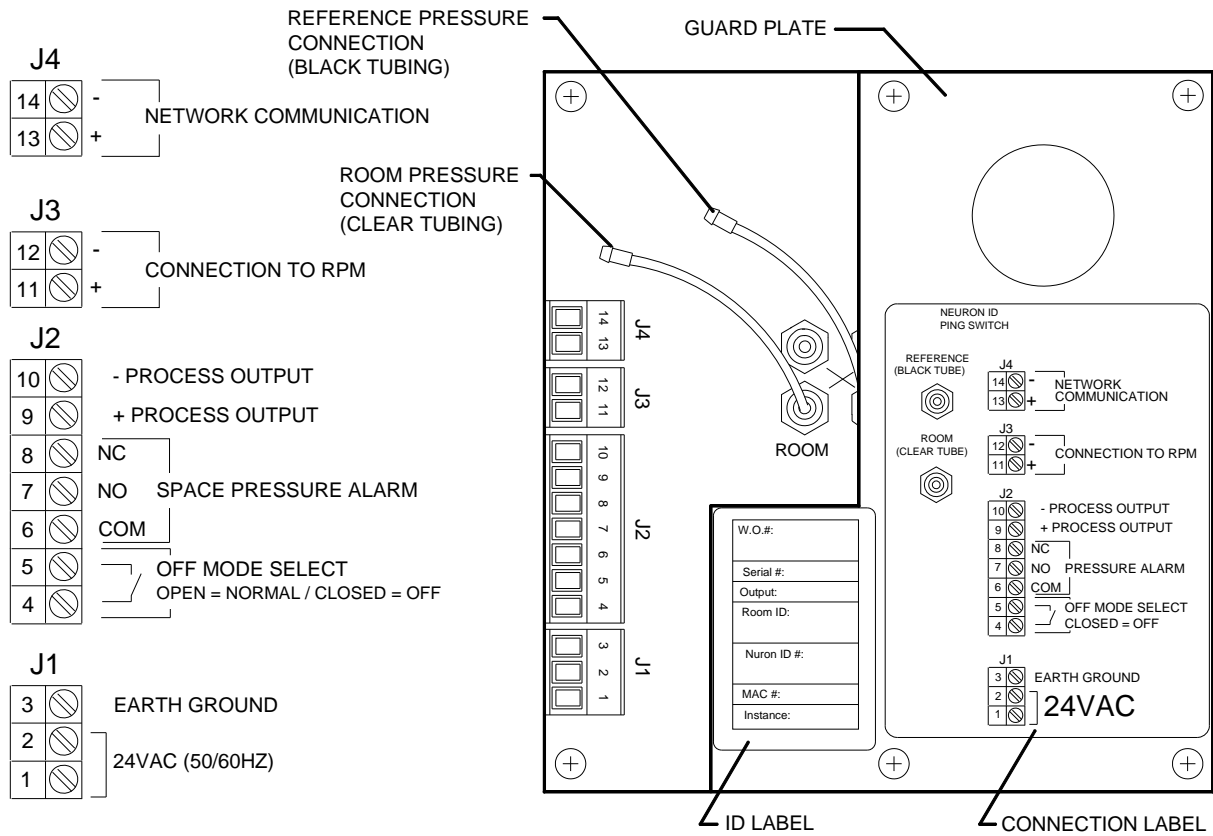

## 3. PRODUCT FEATURES AND DESCRIPTIONS

### 3.1. OFF MODE SELECTS

The Micro Guardian has 5 options available to the user to select the **OFF** Operating Mode.

#### 3.1.1. All Alarms OFF Mode Select

This function will disable all alarms by switching the Operating Mode to **OFF** and can be performed with the front cover attached. To switch to the **OFF** mode, press the **ALARM ACKNOWLEDGE** button 3 times and then hold the button down for 3 seconds. The Micro Guardian Mode LED will change to **OFF**. The alarms can only be restored by repeating the same procedure.

#### 3.1.2. Remote OFF Mode Select

This function will disable all alarms by switching the Operating Mode to **OFF**. This can be performed by attaching a SPST switch to pins 4 & 5 of J2 located on the back side of the board. Contact closure will force the Micro Guardian to the **OFF** mode and an open contact will return the Micro Guardian to the previous operating mode.

#### 3.1.3. Display Field Menu OFF Selection

Removal of the front panel is necessary to perform a Field Menu OFF selection. This function will disable all alarms by switching the Operating Mode to **OFF**.

#### 3.1.4. Network Communication OFF Selection

The Micro Guardian supports LonWorks®, BACnet®-MS/TP Master/Slave or Modbus® Slave communication network protocols. Communication protocols can be used to switch the operating Mode to **OFF**.

#### 3.1.5. Palm Programming Tool

The Palm programming tool allows the user to make an Operating Mode change to **OFF** along with various other changes to the Micro Guardian settings via an IR port located on the front panel.

### 3.2. RPM OUTPUT

Pins 11-12 of (J3) are used to connect to a Paragon Remote Pressure Monitor (RPM-2000).

**Note:** When connecting to an RPM-2000 Remote Pressure Monitor, the MAC code values must be in sequential order. If the MAC values are changed in the field, the new starting value must be entered into the First Room ID menu at the RPM-2000 unit (See RPM-2000 O&M section 3.4).

### 3.3. LONWORKS/BACNET/MODBUS OUTPUT

Pins 13-14 of (J4) are used to connect to a LonWorks®, BACnet®-MS/TP or Modbus communication network. The output requires a LonWorks, BACnet or Modbus daughter board to be installed in the main board.



**3.4. IrDA PORT**

The Micro Guardian unit provides IrDA communication with a PALM handheld unit or PC software MGUSim V4xx. For proper communication, the IrDA instrument must be aligned with the unit IrDA window and the maximum distance must be kept to 1 foot or less.

**3.5. LCD**

An optional backlit two line graphical LCD providing eight characters of data display is used for monitoring pressure, engineering units and Field Menus. The decimal point and polarity will be changed automatically based on the engineering unit and range selection.

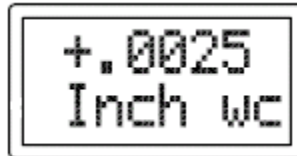

**3.6. AUDIBLE ALARM**

A 85dB (max), 40mA buzzer is used for providing continuous or interval audible alarm. The audible alarm can be acknowledged by pushing the ACK button on the front cover plate. The buzzer output can be enabled or disabled via switch S1-1 located on the front side of the board or thru the Display Field menus. For component location, see Section 2.3.1.

**3.7. LED's**

The Micro Guardian unit has one bi-color, two SMD (Surface-Mount Device), and five solid LED's. LED functions are shown below:

**3.7.1. Field Calibration Bi-color LED (DL8)**

State	Operation State
On	Field Calibration Enabled.
Off	Field Calibration Disabled.
Blink Red	Field Calibration Error.
Blink Green	Field Calibration Correct or in calibration mode (starts blinking 3 times and then turns solid)

**3.7.2. Operation Mode Indicator LED's (DL5, 6,7)**

Mode	Positive (DL5)	Negative (DL6)	Off (DL7)
Positive Room	On	Off	Off
Negative Room	Off	On	Off
Off Room	Off	Off	On

**3.7.3. Normal Status LED (DL3)**

LED State	Operation State
On	Normal state
Off	Alarm state
Blink	Space returns to normal state with no Alarm Acknowledge

**3.7.4. Alarm Status LED (DL4)**

LED State	Operation State
On	Alarm state and Alarm Acknowledged
Off	No Alarm state
Blink	Alarm state with no Alarm Acknowledge

**3.7.5. SMD LED's (DL9-10)**

LED State	Status LED (DL9)	Diag. LED (DL10)
On	IrDA Comm. Established	-
Off	No IrDA Comm.	-
Blink	-	BacNet Data Sending

**3.8. BUTTONS AND SWITCHES**

The Micro Guardian unit has three buttons, two slide switches, and one dip switch. Button and switch functions are shown below (see Section 2.3.1 for component location):

**3.8.1. Button Functions**

Function	Button State
Field Calibration Enable	Press S3 and S4 simultaneously for 3 seconds
Zero Calibration / Enter Field menus / Scroll menus / Exiting the menus	Press S3
Span Max Calibration / Scroll menus / Exiting the menus	Press S4
Span Min (Bi-polar sensor)	Press S4 after span calibration
Alarm Acknowledge / Enter a specific menu / Accepting a new value	Press S2
All Alarms Off	Press S2 3 times and then hold down for 3 seconds. Repeat process to turn alarms back on. Enabling All Alarms Off will override Op Mode setting.

**3.8.2. Switch Functions**

Switch	Function
S5 (Slide switch)	Unit Power On/Off
S6 (Slide switch)	Analog output Voltage/Current select.
S1.1 (Dip switch)	Audible alarm On: Enable Off: Disable
S1.2 (Dip switch)	BacNet RS-485 Termination On/Off

Note: S1.2 in the ON position adds a 200 ohm resistor across the RPM communication terminals for noise suppression when long wire lengths are required.

## 4. FIELD MENUS

The Field Menus allow the user to make changes to alarm values and device settings.

### 4.1. ACCESSING FIELD MENUS

Perform the following steps to enter the Field Menus and make changes. Refer to section 2.3.1 for component locations.

- 3.1.1 Depress and hold the **ZERO** (S3) button for 3 seconds.
- 3.1.2 Depress the **ZERO** button repeatedly to scroll up through the Field Menus or repeatedly depress the **SPAN** (S4) button will scroll down through the menus.
- 3.1.3 To enter a specific Field Menu, depress the **ACKNOWLEDGE** button.
- 3.1.4 To make a change to a value or selection, depress the **ACKNOWLEDGE** button repeatedly to select the digit you want to change and then depress the **ZERO** button to increment the value or the **SPAN** button to decrement the value. Each button depression will change the value by 1 count.
- 3.1.5 Once the change is made, depress and hold the **ACKNOWLEDGE** button for 3 seconds. The new value or selection will be saved, the text <OK> will be displayed and the display will return to the menu.
- 3.1.6 To return to the process display, depress and hold the **ZERO** and **SPAN** buttons for 3 seconds. If the SPM-3000 determines no button activity for 2 minutes, it will return to the process display.

### 4.2. FIELD MENUS

Field Menus
Low Alarm Value
High Alarm Value
Alarm Delay
Audible Alarm
Display Filter
Operation Mode
MAC Code
Instance Number
Baud Rate

### 4.3. LOW ALARM

The Low Alarm menu allows the user to enter a new Low Alarm value. The example shown below is for a Negative room. If the Op Mode is changed from a Negative room to a Positive room, the value shown in the display will be the positive Low Alarm value.

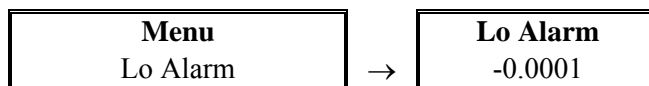

### 4.4. HIGH ALARM

The High Alarm menu allows the user to enter a new High Alarm value. The example shown below is for a Negative room. If the Op Mode is changed from a Negative room to a Positive room, the value shown in the display will be the positive Low Alarm value.

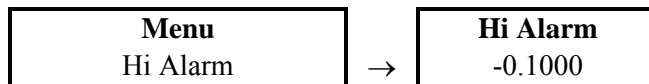

**4.5. ALARM DELAY**

The Alarm Delay menu allows the user to delay alarm activation after an alarm event occurs from 0 to 999 seconds. The default value is 30 seconds.

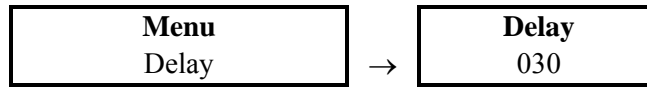

**4.6. AUDIBLE ALARM**

The Audible Alarm menu allows the user to manually turn the audible alarm ON or OFF.



**4.7. DISPLAY FILTER**

The Display Filter menu allows the user to vary the Display Filter rate from 0 to 99 seconds to reach 98% of a step change.

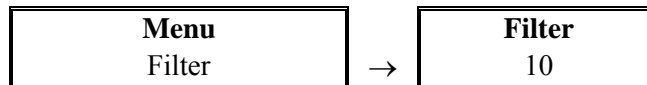

**4.8. OPERATING MODE**

The Operating Mode menu allows the user to change the room being monitored from an OFF room to a positive (POS) or negative (NEG) room. Selection of an OFF room disables alarm status lights, audible alarm and remote alarm relay.

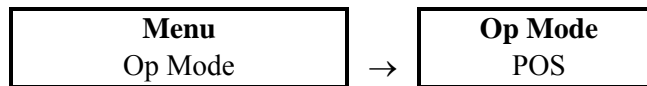

**4.9. MAC CODE (BACNET, MODBUS & RPM COMMUNICATION)**

The MAC Address menu allows the user to set a unique device address when connecting a communication network. The default is 002.

Note: When connecting to an RPM-2000 Remote Pressure Monitor, the MAC code values must be in sequential order. If the MAC values are changed in the field, the new starting value must be entered into the First Room ID menu at the RPM-2000 unit (See RPM-2000 O&M section 3.4).

Note: The MAC Code menu is used to specify the unique BACnet ID for BACnet communication, unique Modbus ID for Modbus communication and RPM ID for RPM communication.

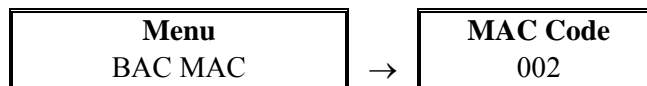

**4.10. INSTANCE**

The Instance Number menu allows the user to set a unique device network address for BACnet communications. The default is 1002.

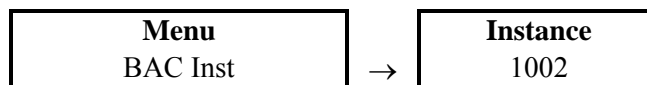

#### **4.11. BAUD RATE**

The Baud Rate menu allows the user to select Baud Rates 9.6K, 19.2K, 38.4K & 76.8K. The default Baud Rate unless specified by the customer is 38.4K.

Note: The Maximum Baud Rate for BACnet MS/TP communications is 76.8K. The Maximum Baud Rate for Modbus communication is 115K.



## 5. FIELD CALIBRATION

The field calibration process can be performed to compensate for slight changes in the pressure sensors over time. Reference Section 2.3.1 for component location.

### 5.1. ZERO CALIBRATION

The following zero calibration procedure can be performed without the need to perform a span calibration.

#### 5.1.1. Procedure

- Step 1. Remove the tubing from the pressure fittings labeled on the board as "ROOM" and "REF". This ensures a zero differential pressure to the transducer.
- Step 2. Press both the Zero (S3) and Span (S4) buttons together for 3 seconds. The Cal LED (DL8) will flash green three times and remain on to indicate that the Micro Guardian is in the calibration mode.
- Step 3. Press and release the Zero button (S3). Wait 5 seconds.
- Step 4. The CPU will begin taking samples. This will last for 5 seconds. The CPU will store this value in a secondary flash memory location and will be used by the CPU instead of the factory calibrated value. The cal LED (DL8) will flash green three times indicating the value was accepted. If the new value is determined to be outside of factory allowed limits the cal LED (DL8) will flash red three times indicating the value was not accepted. If the zero calibration was not accepted, repeat steps 1 thru 4.

### 5.2. BIDIRECTIONAL SPAN CALIBRATION

**Note:** Bi-directional devices can monitor both positive and negative pressure values.

**Note:** It is recommended that a zero calibration be completed before performing a span calibration. Reference Section 2.3.1 for component location.

#### 5.2.1. Equipment Required

- Low pressure air source (Paragon PS-100 or equivalent)
- Manometer for measuring low pressure

#### 5.2.2. Procedure

- Step 1. Remove the tubing from the pressure fittings labeled on the board as "ROOM" and "REF".
- Step 2. Connect the low pressure air source output to the pressure fitting labeled "ROOM".
- Step 3. Press both the Zero (S3) and Span (S4) buttons together for 3 seconds. The cal LED (DL8) will flash green three times and remain on to indicate the Micro Guardian is in the calibration mode.
- Step 4. Apply the positive span pressure value (see the ID label located on guard plate attached to the back of the board).
- Step 5. Once the span pressure is verified, press the Span (S4) button located on the board.

- Step 6. The CPU will begin taking samples. This will last for 5 seconds. The CPU will store this value in a secondary flash memory location and will be used by the CPU instead of the factory calibrated value. The cal LED (DL8) will flash green three times indicating the value was accepted. If the new value is determined to be outside of factory allowed limits, the cal LED (DL8) will flash red three times indicating the value was not accepted. If the positive span calibration was not accepted, repeat Steps 3 thru 5.
- Step 7. Connect the low pressure air source output to the pressure fitting labeled "REF".
- Step 8. Apply and verify negative span pressure value to the transducer.
- Step 9. Once negative span pressure is verified, press the Span button (S4) located on the board.
- Step 10. The CPU will begin taking samples. This will last for 5 seconds. The CPU will store this value in a secondary flash memory location and will be used by the CPU instead of the factory calibrated value. The green cal LED will flash three times indicating the value was accepted. If the new value is determined to be outside of factory allowed limits, the red cal LED will flash three times indicating the value was not accepted. If the negative span calibration was not accepted, repeat Steps 1 thru 9.
- Step 11. Re-connect "ROOM" and "REF" tubing as shown in Section 2.3.2.

### **5.3. UNIDIRECTIONAL SPAN CALIBRATION**

**Note:** Uni-directional devices can monitor only positive pressure values.

**Note:** It is recommended that a zero calibration be completed before performing a span calibration. Reference Section 2.3.1 for component location.

#### **5.3.1. Equipment Required**

- Low pressure air source (Paragon PS-100 or equivalent)
- Manometer for measuring low pressure

#### **5.3.2. Procedure**

- Step 1. Remove the tubing from the pressure fittings labeled on the board as "ROOM" and "REF".
- Step 2. Connect the low pressure air source output to the pressure fitting labeled "ROOM".
- Step 3. Press both the Zero (S3) and Span (S4) buttons together for 3 seconds. The cal LED will flash green three times and remain on to indicate the Micro Guardian is in the calibration mode.
- Step 4. Apply the positive span pressure value (see ID label located on guard plate attached to the back of the board).
- Step 5. Once the span pressure is verified, press the Span (S4) button located on the board

- Step 6. The CPU will begin taking samples. This will last for 5 seconds. The CPU will store this value in a secondary flash memory location and will be used by the CPU instead of the factory calibrated value. The cal LED (DL8) will flash green three times indicating the value was accepted. If the new value is determined to be outside of factory allowed limits, the cal LED (DL8) will flash red three times indicating the value was not accepted. If the positive span calibration was not accepted, repeat Steps 3 thru 6.
- Step 7. Re-connect "ROOM" and "REF" tubing as shown in Section 2.3.2.



## 6. TROUBLESHOOTING GUIDE

TROUBLESHOOTING TABLE	
SYMPTOM	SOLUTION
<p>1. Status &amp; Mode LED's are not illuminated/LCD Display is Blank</p>	1. Verify ON/OFF switch is in ON position (see Section 2.3.1).
	2. Verify correct input power and connection at connector J1 (see Section 2.3.2).
	3. Verify input power wire insulation has been properly removed and the wire fully inserted into the J1 power plug.
	4. Contact Factory Service Department.
<p>2. Display characters are too dim or too dark</p>	1. Remove front cover. Adjust Display potentiometer R87 located at the top of the LCD board.
	2. Contact Factory Service Department.
<p>3. Display reads <b>zero pressure</b> and does not respond to input pressure changes</p>	1. Verify room calibration pressure tubing is connected as shown in Section 2.3.2.
	2. Squeeze each room calibration tube independently with your fingers. If the display responds, proceed to step 3. If the display does not respond, contact Factory Service Department.
	3. Turn the power switch to OFF. Remove the Micro Guardian from the wall box and verify the input signal tubing is connected as shown in Section 2.3.2.
	4. Contact Factory Service Department.
<p>4. Display is reading a pressure but does not respond to input pressure changes</p>	1. Turn the power switch to OFF. Remove the Micro Guardian from the wall box and inspect for possible pinched or disconnected tubing. Reinstall and verify operation.
	2. Remove ROOM and REF end of Room Calibration tubing (see Section 2.3.1). If the display returns to a zero reading, check for pinched or plugged tubing at the PE-4000 pressure sensor or input signal lines. If the display does not respond, contact the factory Service Department.

<b>TROUBLESHOOTING TABLE</b>	
<b>SYMPTOM</b>	<b>SOLUTION</b>
5. No Process output (Voltage/Current) or Incorrect Output  5. No Process output (Voltage/Current) or Incorrect Output (Continued)	1. Verify correct output selection (see S6 in Section 2.3.1).
	2. Disconnect output signal wires and verify output signal at Micro Guardian connector J2 is correct (see Section 2.3.2).
	3. Contact Factory Service Department.
6. Audio Alarm not functioning	1. Verify switch S1-1 is in the ON position (see Section 2.3.1).
	2. Verify correct alarm setpoint values.
	3. Verify alarm is not turned OFF via the Menu or communication network.
	4. Verify MODE LED <b>OFF</b> is not illuminated on Front Panel (see Sections 3.1.1 and 3.1.7.2)
	5. Contact Factory Service Department.
7. Red Alarm LED remains ON	1. Verify alarm setpoint values.
	2. Verify input pressure tubing is connected correctly (see Section 2.3.2)
	3. Contact Factory Service Department.
8. Operation Mode indicator LED is in OFF and can not be changed via communication network.	1. See Section 3.1.8.1 Button Functions - All Alarms OFF section. Follow the instructions to restore Operation Mode.
	2. Verify J2 pins 4 and 5 are not connected via a jumper wire or wired to a remote switch that is activated (see section 2.3.2).
	3. Contact Factory Service Department.
9. LonWorks not communicating with the Micro Guardian	1. Turn power switch OFF. Remove Micro Guardian from the wall box. Carefully turn power switch ON. Press service pin (S1) located on the LonWorks board. Turn power switch to OFF and reinstall Micro Guardian.
	2. Swap wires on J4 pins 13 & 14 (see Section 2.3.2).

<b>TROUBLESHOOTING TABLE</b>	
<b>SYMPTOM</b>	<b>SOLUTION</b>
	3. Refer to Lon Communication O&M
	4. Contact Factory Service Department.
10. BACnet or Modbus not communicating with the Micro Guardian	1. Verify two devices do not have the same Instance Number and MAC code. Change to an unused Instance Number and MAC code.
	2. Verify wires connected to J4 pins 13 & 14 are correct. If not, swap the wires and retest. (See section 2.3.2)
	3. Refer to BACnet or Modbus Communication O&M.
	3. Contact Factory Service Department.

